

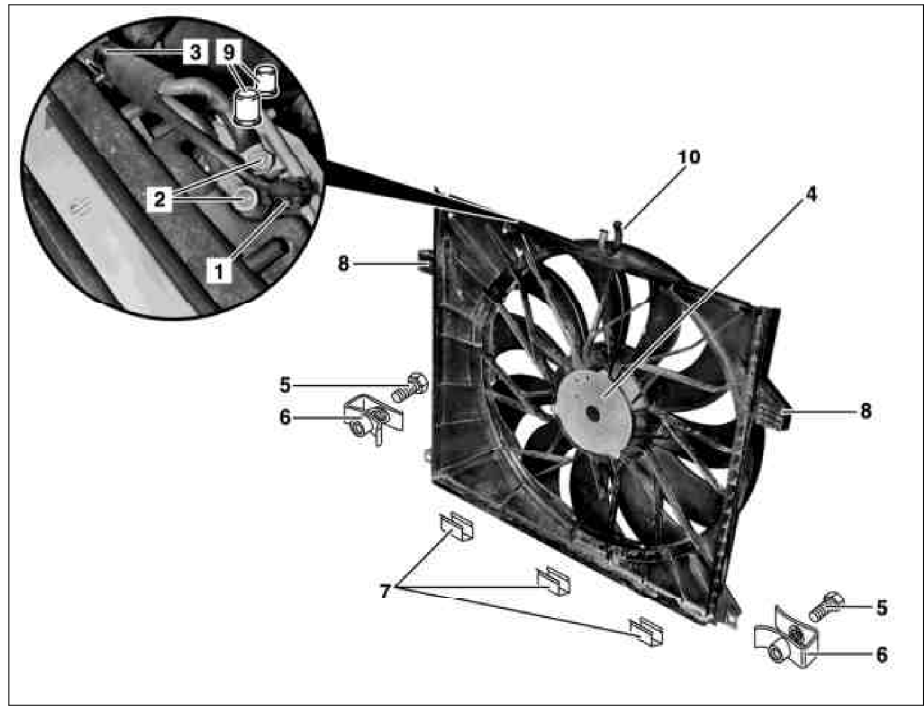





ENGINE 113.965 in MODEL 163.175

ENGINE 113.981 in MODEL 163.174

- 1 Connector
- 2 Electrical connections
- 3 Tie strap
- 4 Electric fan
- 5 Screws
- 6 Sheet metal nuts
- 7 Sheet metal clamps
- 8 Retainer tabs
- 9 Protective caps
- 10 Bracket



P20.40-2025-06

 	Remove/Install		
1	Disconnect electrical plug (1).		
2	Unbolt electrical connections (2)	<p> For this step detach protective caps (9).</p> <p> Insulate wire ends, in order to avoid a short circuit due to an unintended ground contact.</p>	
3	Unclip cable straps (3)		
4	Press coolant hose out of bracket (10)		
5	Remove engine compartment paneling		AR61.20-P-1105GH
6	Unbolt electric fan (4) at the bottom	<p> For this step unscrew bolts (5) and remove sheet metal nuts (6).</p>	
7	Take off plate clamps (7)		
8	Remove electric fan (4)	<p> Installation: Ensure, that the retainer tabs (8) of the electric fan are seated in the mounts of the radiator on right and left</p>	
9	Install in the reverse order		