

ENGINE 112.942 in MODEL 163.154
 ENGINE 112.970 in MODEL 163.157
 ENGINE 113.942 in MODEL 163.172
 ENGINE 113.981 in MODEL 163.174
 ENGINE 113.965 in MODEL 163.175

Shown on model 163.154 with engine 112

- 1 Air baffle
- 2 Viscous fan
- 3 Fan shroud
- 4 Bolts
- 5 Air cleaner housing
- 6 Air intake manifold
- 7 Resonance unit
- 8 Poly-V-belt
- 9 Fender liner
- 10 Shield
- 11 Exhaust bracket

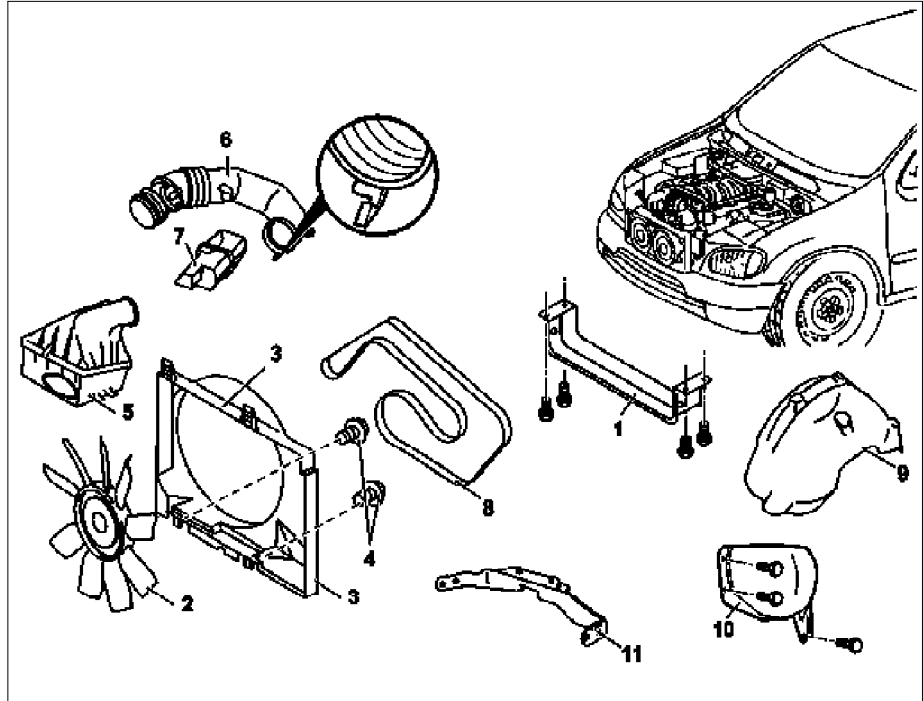

P01.30-2032-06

- 12 Right and left ignition coils
- 13 Left and right cylinder head covers
- 14 Intake manifold
- 15 Camshaft position sensor
- 16 Coolant line
- 17 Chain tensioner
- 18 Oil filter housing
- 19 Camshaft sprockets
- 28 Camshaft bearing bridges

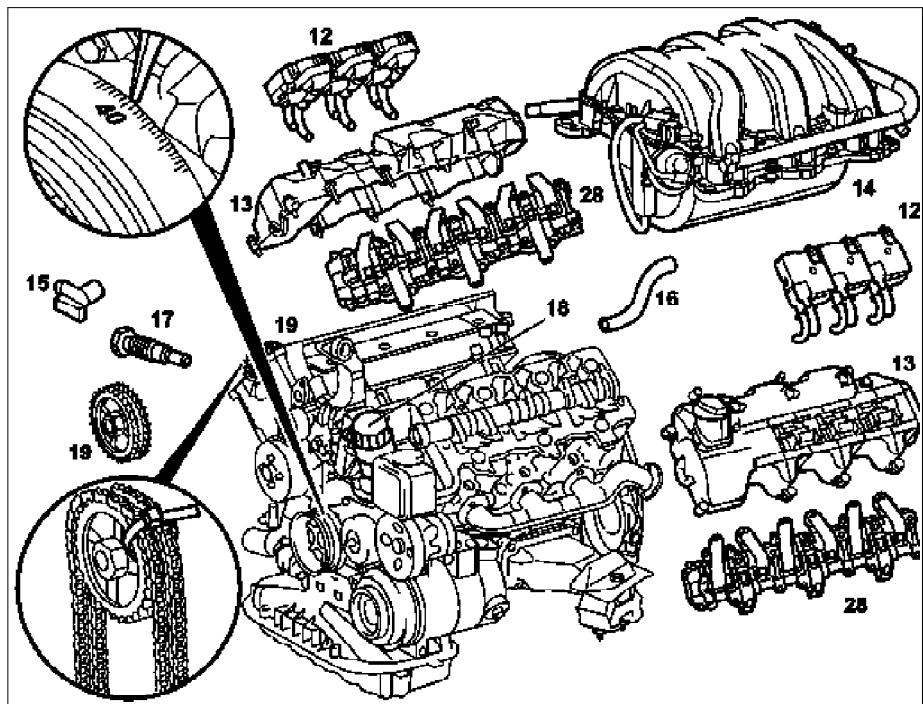

P01.30-2033-06



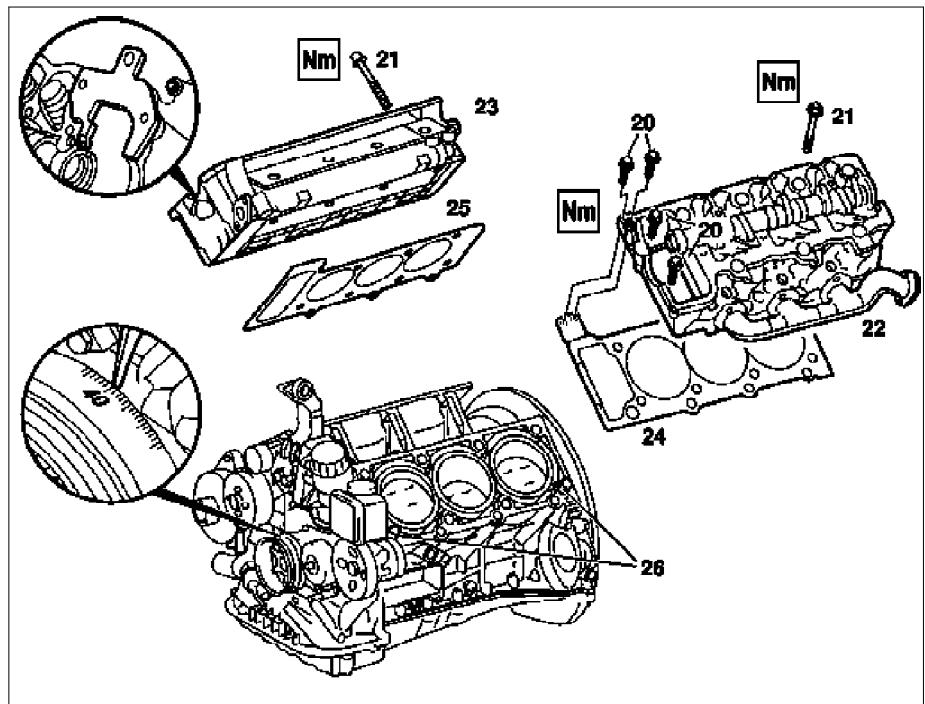



















- 20 Bolts cylinder head timing case cover
- 21 Cylinder head bolts
- 22 Cylinder head left
- 23 Cylinder head right
- 24 Left cylinder head gasket
- 25 Right cylinder head gasket
- 26 Dowel sleeves



P01.30-0299-06

☒ ☒	Remove/Install		
ⓘ	Notes on self-locking nuts and bolts	All models	AH00.00-N-0001-01A
ⓘ		<input checked="" type="checkbox"/> External torx set <input checked="" type="checkbox"/> Torx bit set	*001589760900 *000589011000
⚠ Danger! 1 ⓘ	Risk of explosion caused by oxyhydrogen gas. Risk of poisoning and caustic burns caused by swallowing battery acid. Risk of injury caused by burns to skin and eyes from battery acid or when handling damaged lead-acid batteries Disconnect battery ground cable ⓘ Notes on battery	No fire, sparks, open flames or smoking. Wear acid-resistant gloves, clothing and safety glasses. Pour battery acid only into suitable and appropriately marked containers. ⓘ Installation: After connecting, read out fault memory, encode radio and normalize power windows. Vehicles with stationary heater: Set time on timer for stationary heater All models	AS54.10-Z-0001-01A AR54.10-P-0003A AH54.10-P-0001-01A
⚠ Danger! 2	Risk of death caused by vehicle slipping or toppling off of the lifting platform. Place the vehicle on lifting platform	Align vehicle between the columns of the hydraulic hoist and position the four support plates below the hoist support points specified by the vehicle manufacturer.	AS00.00-Z-0010-01A AR00.60-P-1000GH
3.1	Remove air guide (1)	ⓘ Only with engine 113.942	
⚠ Danger! 4	Risk of injury to skin and eyes suffering scalding from contact with hot coolant spray. Risk of poisoning from swallowing coolant. Drain coolant	Do not open cooling system unless coolant temperature is below 90 °C. Open cap slowly and release the pressure. Do not pour coolant into beverage bottles. Wear protective gloves, protective clothing and eye protection. ⓘ Remove coolant hose at bottom on radiator.	AS20.00-Z-0001-01A AR20.00-P-1142HA
5	Remove engine cover		
6.1	Remove viscous fan (2)	ⓘ All except model 163.174 /175 with engine 113.981 /965. ⓘ Right-hand thread!	AR20.40-P-5660C
7.1	Remove the fan shroud (3).	ⓘ Only model 163.154 /157 /172. Unscrew bolts (4) from bottom of fan shroud	
7.2	Remove electric fan	ⓘ Only model 163.174/ 175.	AR20.40-P-5000GH

8 y	Attach guard plate for radiator/condenser Guard plate for radiator/condenser	Engine 606 in model 124, Engine 606.961 in model 140, Engine 112, 113, 604, 605, 611.960 in model 202, Engine 602.983, 612.966 in model 461, Engine 628.962, 612.965, 606.964, 112.945, 113.962/ 982 in model 463, Engine 111, 112, 611.962, 612.962 in model 203, Engine 112, 113, 611.961, 612.961, 613.961 in model 210, Engine 112 in model 170, Engine 112 in model 220, Engine 113 in model 211, 215, 220, Engine 112 in model 208, Engine 112, 113, 612.963, 628.963 in model 163, Engine 112.923 /943, 113.961 in model 129, Engine 137, 275 in model 215, 220, Engine 613.960, 628.960 in model 220, Engine 113.992 in model 230.474, Engine 271 in model 209, 203, Engine 285.950 in model 240.078 /178, Engine 612.967 in model 209.316, Engine 648 in model 220 Engine 112.951 in model 639.601/603/ 605/ 701 /703 /705 /801 /803 /805 Engine 646.983 /984 in model 639.601/ 603 /605 /701 /703 /705 /801 /803 /805 Engine 646.982 in model 639.601/ 603/ 605/ 701 /703 /705	WF58.50-P-0110-01A
9	Remove air cleaner housing (5)		
10	Remove air intake pipe (6) with resonance tube (7)	<p>i Separate connector of hot film mass air flow sensor (HFM) for this step and unbolt air intake pipe at cylinder head cover</p> <p>i The air intake pipe is attached at the rear at the intake manifold with a plastic plate.</p> <p>i Do not damage the plastic strap.</p> <p>Engine 112.942/ 970 Engine 113.942/ 965/ 981</p>	AR07.07-P-1454A AR07.07-P-1454MV
⚠ Danger! 11	Risk of explosion caused by fuel igniting, risk of poisoning caused by inhaling and swallowing fuel as well as risk of injury to eyes and skin caused by contact with fuel. Disconnect fuel line at fuel rail	<p>No fire, sparks, open flames or smoking. Pour fuels only into suitable and appropriately marked containers. Wear protective clothing when handling fuel.</p> <p>i Release fuel pressure at service valve!</p> <p>i Collect fuel!</p> <p>i Engine 112:# Nm</p> <p>i Engine 113:# Nm</p> <p>🔧 Pressure hose</p>	AS47.00-Z-0001-01A *BA07.52-P-1001-01A *BA07.52-P-1001-01A *119589046300
12	Remove right and left ignition coils (12)		AR15.12-P-2003A
13	Remove right and left cylinder head covers (13)		AR01.20-P-5014B
14	Remove the intake manifold (14)	<p>⚠ Installation: On vehicles with engine damage, the intake manifold must be examined for swarfs before assembling and any swarfs present must be removed, in order to avoid consequential damage.</p> <p>i The intake manifold system must not be disassembled.</p> <p>i Remove intake manifold with fuel distributor</p>	AR09.20-P-1310A
15.1	Remove camshaft position sensor (15)	i Only necessary if the right cylinder head is removed.	AR15.10-P-2000A

16	Remove poly V-belt (8)	 Installation: Lock tensioning device with a drift or pin (diameter 5 mm). Model 163.154 /157 /172. Model 163.174 /175.	AR13.22-P-1202B AR13.22-P-1202BA
17	Detach the coolant line (16) at the cylinder head on the left	 6 mm socket hexagon  7 mm socket hexagon	*WH58.30-Z-1001-06A *WH58.30-Z-1002-06A
18.1	Remove fender liner (9)	 Only with engine 113.113.942 /965 / 981.	AR88.10-P-1300GH
19.1	Remove shield (10)	 Only with engine 113.942 /965 /981.	
20.1	Remove exhaust bracket (11)	 Only with engine 113.942 /965 /981.  Support exhaust system.	
21	Detach exhaust system at exhaust manifold	 Installation: On vehicles with engine damage, the exhaust system must be examined for swarfs before assembling and any swarfs present must be removed, in order to avoid consequential damage. 	*BA14.10-P-1002-01B
22	Position crankshaft to 40° after ignition TDC on cylinder 1	 The engine must not be turned back; otherwise the timing chain can get jammed.  Rotate engine at the crankshaft in running direction until scribe mark 40° on pulley/ vibration damper corresponds with scribe mark on timing case. The grooves on the camshafts must be pointing toward the inner V.	AR05.10-P-6858V
23	Lock camshafts with locating plates	 Locating plate  Locating plate	*112589003200 *112589013200
24	Remove chain tensioner (17)	Model 163.154 /157 with engine 112.942/ 970, model 163.172 with engine 113.942. Model 163.174 /175 with engine 113.981/ 965.	AR05.10-P-7800C AR05.10-P-7800CA
25.1	Remove oil filter housing (18) together with oil-water heat exchanger	Engine 113.942. Engine 112.942/970.	AR18.20-P-3471B AR18.20-P-3471BA
26	Unscrew camshaft sprockets (19)	 If camshaft sprockets are removed, engine must no longer be cranked, otherwise timing chain might jam.  Engine 113.942 /965 /981: # Tie timing chain tight on both camshaft sprockets with tie straps. Engine 112.942 /970: # Right-hand camshaft sprocket: Tie timing chain tight on camshaft sprocket with tie strap. Left-hand camshaft sprocket: Mark camshaft sprocket to timing chain and remove camshaft sprocket.  It is not possible for the timing chain to jump across at the crankshaft and balancing shaft.  After installation:# Inspect basic position of camshafts. If necessary after checking: # Set the basic position of camshafts  Open-end wrench  Insertion tool  Torque wrench 	AR05.10-P-6858V AR05.20-P-6020AU *112589000100 *112589010300 *001589722100 *BA05.20-P-1001-01B
27	Remove camshaft bearing bridges (28)	 Pay attention to slackening and tightening pattern!	AR05.20-P-7103AU
28	Unscrew bolts, cylinder head ! timing case cover (20)		*BA01.40-P-1002-01C

29	Slacken cylinder head bolts (21) in stages, unscrew	<p>ⓘ Loosen cylinder head bolts according to loosening schematic only after engine has cooled down to prevent cylinder head from distorting.</p> <p>ⓘ Installation: Observe tightening pattern and tightening instructions of cylinder head bolts.</p> <p>Oil thread and head contact surface of cylinder head bolts.</p> <p>🔧 Screwdriver insert</p> <p>🔧 Screwdriver insert</p> <p>Ⓜ</p>	AR01.30-P-5800-09B AR01.30-P-5800-07B *000589031000 *000589041000 *BA01.30-P-1001-01D
30	Remove cylinder head ⓘ Notes on application of sealant to cylinder head gasket.	<p>ⓘ Installation: On Engine 112/113 observe porous points in the left and right cylinder head. If porous points are present, sealant must be applied to the cylinder head gasket. Engine 112, 113</p> <p>ⓘ The sealant must be applied within 10 minutes. Loctite 5900 sealant.</p>	AH01.30-P-1000-04VA *BR00.45-Z-1015-01A
31	Inspect version of cylinder head gasket Information for assigning the cylinder head gaskets	Assignment of cylinder head gasket Engine 112, 113	AH01.30-P-1000-06V
32	Check cylinder head bolts (21)	🔧	AR01.30-P-5800-03B *BE01.30-P-1001-04B
33	Clean sealing surfaces, inspect for cracks, shrink holes and flatness, clean threaded holes.	<p>ⓘ Pay attention to dowel sleeves (26) for locating the cylinder head.</p> <p>ⓘ Sealing surfaces of crankcase and cylinder head are provided with an 0.8 mm thick silicone layer during series production. At the time of repair installation, silicone sealant is applied to the sealing area only in case of any shrink holes.</p> <p>ⓘ The sealant must be applied within 10 minutes. Loctite 5900 sealant.</p>	*BR00.45-Z-1015-01A
34	Install in the reverse order		
35	<p>⚠ Danger!</p> <p>Risk of accident caused by vehicle starting off by itself when engine is running. Risk of injury caused by contusions and burns when working in engine during starting procedure Run engine and inspect for leaks</p>	Secure vehicle to prevent it from moving. Wear closed and snug-fitting work clothes. Do not grasp hot or rotating parts.	AS00.00-Z-0005-01A
36	Inspect cooling system for leaks	ⓘ Warm up engine to operating temperature and then inspect cooling system or leaks.	AR20.00-P-1010HA
37	Read out and erase fault memory	ⓘ Stored faults which can result from cables being disconnected or from simulation during removal and installation or test work, have to be processed and erased in the fault memories after completing the work: #	
		Diagnosis Manual Volume 2 Index 0: Connecting and using test equipment.	

Cylinder head/cylinder head bolts

Number	Designation		Engine	Engine
			112.910/911/912/ 913/914/915/ 916/917/920/ 921/922/923/ 940/941/942/ 943/944/945/ 946/947/949/ 951/953/954/ 955/960/961/ 970/972/973/975	113.940/941/ 942/943/944/ 945/946/948/ 960/961/962/ 963/965/966/ 967/968/969/ 980/981/982/ 984/986/987/ 988/990/991/ 992/993
BE01.30-P-1001-04B	Cylinder head bolt	Thread diameter	M 11	11
		Length (L) when new	mm 141.5	141.5
		Length (L)	mm T 144.5	T 144.5

Nm Cylinder head

Number	Designation		Engine 112.910/911/912/ 913/914/915/ 916/917/920/ 921/922/923/ 940/941/942/ 943/944/945/ 946/947/949/ 951/953/954/ 955/960/961/ 970/972/973/975	Engine 113.940/941/ 942/943/944/ 948/960/961/ 962/963/965/ 966/967/968/ 969/980/981/ 982/984/986/ 992
BA01.30-P-1001-01D	Bolt of cylinder head to crankcase	1st stage Nm	10	10
		2nd stage Nm	30	30
		3rd stage (°	90	90
		4th stage (°	90	90

Nm Crankcase, timing case cover, end cover

Number	Designation	Engine 112 except 112.951	Engine 113.940/941/ 942/943/944/ 945/946/948/ 960/961/962/ 963/965/966/ 967/968/969/ 980/981/982/ 984/986/992	
BA01.40-P-1002-01C	Bolt, cylinder head to timing case cover	Nm	20	20

Nm Camshaft

Number	Designation	Engine 112 except 112.951	Engine 113.940/941/ 942/943/944/ 948/961/962/ 963/965/966/ 967/968/969/ 980/981/982/ 984/986/992		
BA05.20-P-1001-01B	Bolt of camshaft sprocket	M12 x 45	1st stage Nm	50	50
			2nd stage (°	90	90

Nm Fuel rail

Number	Designation	Engine 112 except 112.945/951/ 960/961	
BA07.52-P-1001-01A	Fuel feed line to fuel rail	Nm	38

Nm Fuel rail

Number	Designation	Engine
		113.940/941/ 942/943/944/ 945/946/948/ 960/961/962/ 963/965/966/ 967/968/969/ 980/981/982/ 984/986/988/
BA07.52-P-1001-01A	Fuel feed line to fuel distributor	Nm 38

Nm Exhaust manifold

Number	Designation	Engine	Engine
		112 except 112.951	113.940/941/ 942/943/944/ 945/946/948/ 960/961/962/ 963/965/966/ 967/968/969/ 980/981/982/ 984/986/992/ 993
BA14.10-P-1002-01B	Flange connection of exhaust manifold or front exhaust pipes	Nm 20	20

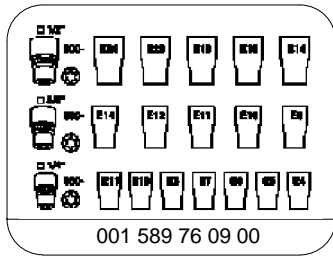

001 589 76 09 00

External Torx set

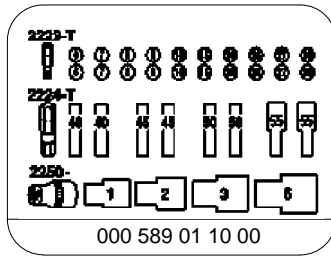

000 589 01 10 00

Torx bit set

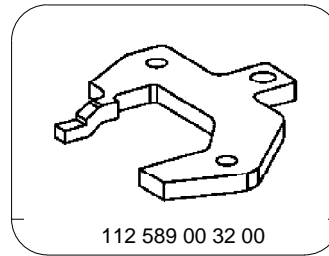

112 589 00 32 00

Locating plate

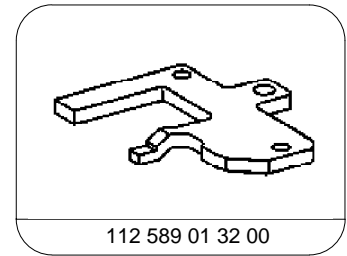

112 589 01 32 00

Locating plate

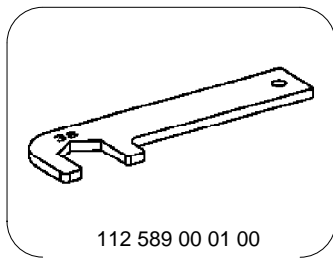

112 589 00 01 00

Open-end wrench

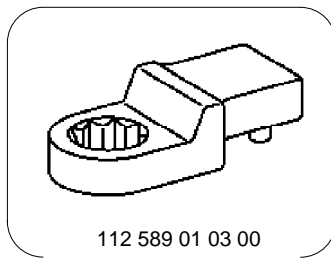

112 589 01 03 00

Insertion tool

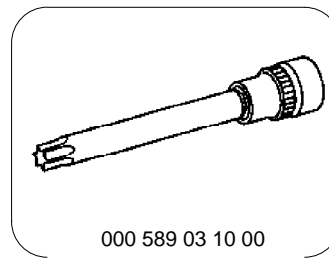

000 589 03 10 00

Screwdriver insert

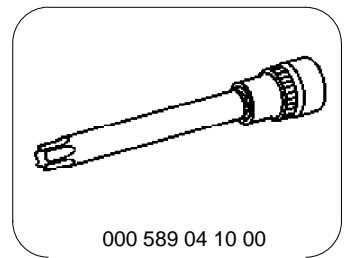

000 589 04 10 00

Screwdriver insert

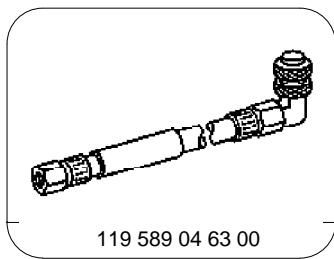

Pressure hose

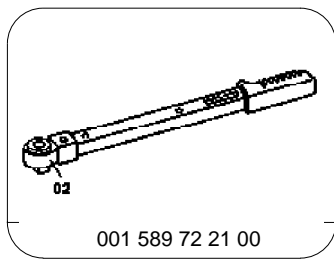

Torque wrench

Commercially available tools (see Workshop Equipment Manual)

Number	Designation	Make (e. g.)	Order number
WH58.30-Z-1001-06A	6 mm socket hexagon on flexible shaft for hose clamps with worm drive	Hazet Güldenwerther Bahnhofstraße 25-28 D-42857 Remscheid	426-6
WH58.30-Z-1002-06A	7 mm hexagon socket wrench to flexible shaft for hose clips with worm drive	Hazet Güldenwerther Bahnhofstraße 25-28 D-42857 Remscheid	426-7

Auxiliary repair materials

Number	Designation	Order number
BR00.45-Z-1015-01A	Loctite sealant 5970	A 003 989 98 20 10