



UNIVERSAL RDS

INTEGRATION KIT

Installation Guide/User manual

Made for



iPod



iPhone

Copyrights and Trademarks

Copyright 2011 DICE Electronics, LLC.

The DICE Electronics logo is a trademark of DICE Electronics, LLC.

iPod is trademark of Apple, Inc.

All rights reserved.

Printed in the U.S.A.

Table of Contents

Warning and safety	4
Product registration	5
Universal RDS kit contents	6
Frequency configuration settings	6
Compatible iPod & iPhone Models	7
Installation	8
Connection diagram	9
Note to Installers	10
Charging	11
Basic operation	12
Optional wireless remote function for iPod	13
Troubleshooting	14
Firmware update	17
Disclaimer & Warranty	18
Installation notes	19

Warning and safety!

Please read these instructions carefully before proceeding. Failure to follow instructions may result in improper operation or injury. Neither DICE Electronics, LLC. nor Apple Inc., its regional offices, distributors or resellers take any responsibility for any damage or injury as a result of using the integration kit.

- Do not open, disassemble or alter the interface in any way.
- Do not insert anything into the casing.
- Do not cut or try to alter cables in any way and always use the correct connections.
- Only operate unit when stationary or ask passengers to operate it for you.
- Do not allow the Apple iPod to distract you from driving.
- Exercise good judgement and keep your eyes on the road at all times.
- Do not expose unit to extreme temperatures, humidity or shock.
- Keep the unit and iPod away from fluids.
- Keep away from children! - Interface components may contain small parts, can be broken or disassembled and components may become loose from vibration and heat. Small components and packaging materials may be a choking hazard when handled by children.



Congratulations on your purchase!

Thank you for purchasing the DICE Universal RDS integration kit for iPod. Please review our user manual and installation guide before operating the unit. This interface was designed and manufactured to seamlessly integrate with your vehicle's factory entertainment system.

Product registration

In order to validate your warranty period and to receive telephone or online support and product firmware updates, you **MUST** register your DICE product.

To register your DICE product, please complete the following steps:

1. Visit <http://www.register.diceelectronics.com>
2. Look up and save the serial number of the product.
3. Complete the product registration form.
4. Submit the form.
5. Save the registration/support/warranty sheet in a safe place for future reference.

If you are unable to complete the registration via internet, please call DICE Electronics at 1-888-342-3999.

Universal RDS kit contents

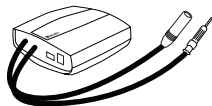

Universal RDS module



user manual



pro-install power
cable

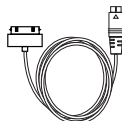

DICE dock
cable



IR receiver
(optional)

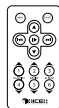

wireless remote
(optional)

Frequency configuration settings:

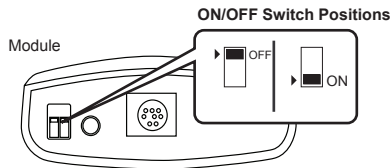

frequency selector switch

FM (MHz)	Dip switch 1	Dip switch 2
88.7	OFF	OFF
93.3	ON	OFF
97.5	ON	ON
107.7	OFF	ON

Supported iPod models and firmware version requirements

Model	Firmware / OS Version
1G nano	1.3.1
iPod 5G	1.3
2G nano	1.1.3
iPod classic	1.1.2
3G nano	1.1.3
iPod touch	iOS 3.1.3
iPhone	iOS 3.1.3
iPhone 3G	iOS 4.2.1
4G nano	1.0.4
120 GB classic	2.0.1
2G touch	iOS 4.2.1
iPhone 3GS	iOS 4.2.1

Model	Firmware / OS Version
160 GB classic	2.0.4
5G nano	1.0.2
3G touch	iOS 4.2.1
iPhone 4	iOS 4.2.1
4G touch	iOS 4.2.1
6G nano	1.1

Installation

1. Verify compatibility, certain radios require antenna adapter(s), not included in the kit.

2. Disconnect battery

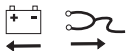

3. Remove radio from car

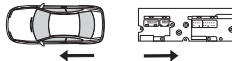

4. Set the DIP switches for the frequency selector switch to the desired setting.



5. Install Universal RDS cable. Plug the factory radio antenna to the receptacle on the module.

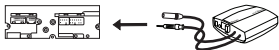

6. Test for 12V constant, 12V switched, and ground sources. Splice into with leads from power cable.

7. Route kit to glovebox or other accessible location.

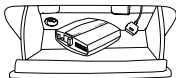

8. Connect battery & test*



9. Complete install by re-installing radio



10. Save frequency to a preferred preset on the radio if desired.

UNIVERSAL RDS

Connection Diagram

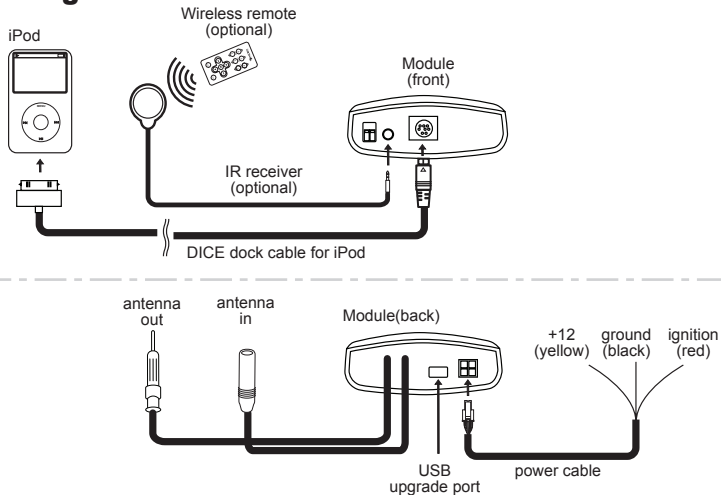

Attention installer! Please read the following!

DICE Electronics strongly recommends that the unit be installed in an easily accessible place!

DO NOT PLACE IT BEHIND THE RADIO!

Whether the unit is professionally or self installed, put the module where you, the end user can get to it easily in the future. (Have the installer show you where the box is.)

Installing the DICE module behind the radio will make it difficult to:

- Add possible future upgrades, changing software, adding new features, improving operation;
- Access the DIP switches located on the module;
- Remove the unit in case of failure.

MAKE SURE THAT THE MODULE IS IN AN ACCESSIBLE PLACE!

Charging

The interface automatically charges the battery of the iPod when connected and your vehicle ignition key is in the ON position.

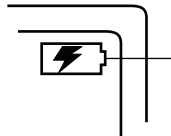

Charging may be shown by an icon that appears on the upper right corner of the iPod screen. May vary by model.

Basic Operation

1. Power on the radio and select the FM source.
2. Tune the radio to the frequency set by the configuration switches (see pg 6)
3. Connect your iPod or iPhone via DICE docking cable for iPod to the Universal RDS module.
4. Select/control desired music on you iPod/iPhone.
5. Use the optional wireless remote for control.

UNIVERSAL RDS

Optional wireless remote function for iPod

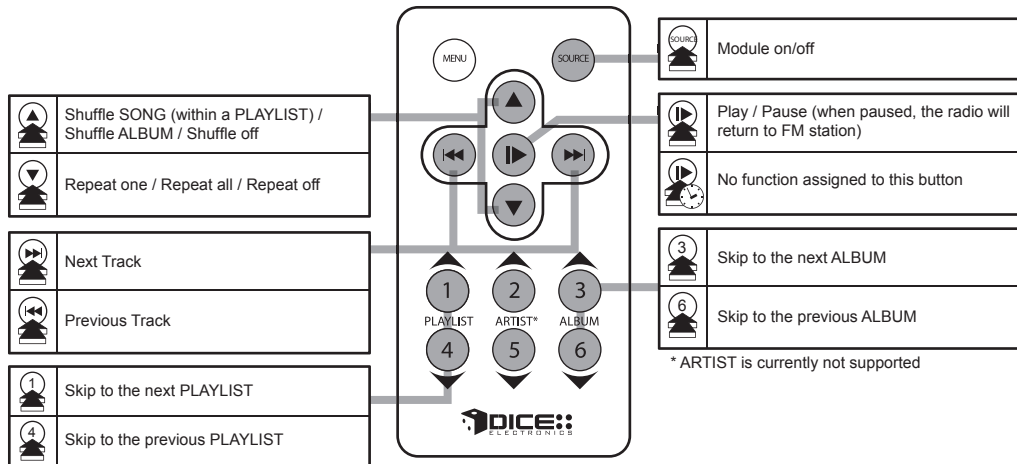

Troubleshooting

Problem	Solution
Text is not displaying on the screen of the radio.	Text from the iPod will only display if the radio is RDS capable. Look for RDS capability: RDS capable radios will show text in addition to the frequency such as song information while listening to certain FM stations.
iPod does not charge.	Check all connections. See if iPod charges while connected to computer or wall charger. You may need to reset the iPod.
Music is distorted or sound level is too low with iPod connected.	Make sure all EQ and BASS boost options are turned off on your iPod.
Why is the remote not controlling the iPod?	Please make sure that the iPod dock connection is not loose. Make sure that an iPod case is not preventing the dock connector from being fully seated. Disconnect and reconnect the device. If iPod is not responding please try resetting it. Check the wireless remote's battery and IR receiver connection.

UNIVERSAL RDS

Problem	Solution
No audio from iPod source.	Reset the iPod. Verify proper connection to iPod/interface. Check for compatibility.
Why does the radio display show “EMPTY/STOP” and no music plays?	The iPod does not have playable audio files or end of a playlist is reached. Please select a new Playlist by browsing there on the iPod or remote.
Cannot hear audio from iPod.	Check DIP switch settings and make sure that radio is tuned to selected frequency. With the ignition OFF, disconnect Power harness from module for a few seconds and reconnect.
Why does category read “PRESELCTD”?	Playback of content selected on the iPod before connected to the interface continues until new content is selected.

Problem	Solution
Text from iPod/iPhone music App doesn't show.	Audio stream from internet radio is routed through the Universal RDS kit, but text information is not available.
I can't control the iPod/iPhone from the radio.	Content control must be done directly on the iPod/iPhone, or via the optional remote control.
Cannot hear AM/FM radio stations.	<p>When an iPod/iPhone is connected to the Universal RDS kit, the interface cuts out the factory antenna feed to prevent interference from strong local stations. Disconnecting the iPod/iPhone restores the antenna connection.</p> <p>If you have the optional remote control, you can press the SOURCE button to switch between iPod/iPhone and factory antenna feed.</p>

Firmware update

STEP 1: Disconnect the Universal RDS module from the vehicle.

STEP 2: Download and install necessary software from www.diceelectronics.com

STEP 3: Open software to follow instructions for updating Universal RDS unit.

STEP 4: Plug in Universal RDS via mini USB cable and update.

STEP 5: Disconnect and reinstall the unit into the vehicle.

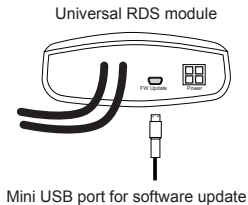

Disclaimer & Warranty

Important disclaimer, please read!

Unauthorized reproduction or reverse engineering is strictly prohibited! Intellectual property included is distributed under specific license agreement with respective owners and is licensed only, not sold. No warranty, explicit or implied, is stated. Neither DICE Electronics, LLC., nor any of its agents, distributors, dealers or vendors shall be liable for damages.

IN NO EVENT SHALL DICE ELECTRONICS' LIABILITY EXCEED THE PRICE PAID FOR THE PRODUCT FROM DIRECT, INDIRECT, SPECIAL, INCIDENTAL, OR CONSEQUENTIAL DAMAGES RESULTING FROM THE USE OF THE PRODUCT, ITS ACCOMPANYING SOFTWARE OR ITS DOCUMENTATION.

Support and warranty!

If you experience any problems or need help, please contact you local dealer or call DICE Electronics, LLC. At 888-342-3999 or visit us at <http://diceelectronics.com/product-support>

Products carry a 1 year limited warranty that protects you from defects in material and workmanship of products sold by DICE Electronics or its authorized agents, distributors and dealers. The warranty period begins the day a product is purchased by the end user. Products found to be defective during the warranty period will either be repaired or replaced by DICE Electronics at no charge unless warranty is void. Unauthorized attempt of repair or alteration of the product in any way immediately voids this warranty. Warranty does not extend to cosmetics or finish. A DICE product specialist must determine that a defect is present in the product and issue an RMA. Be sure that all wiring is connected as described in the user manual and all related equipment is functioning properly. DICE Electronics disclaims any liability for other incurred damages resulting from product defects. Any expenses in the removal and reinstallation of products are not covered by this warranty.

PLEASE NOTE: International customers requiring a product replacement, please contact the dealer your product was purchased from!

UNIVERSAL RDS

Installation notes:

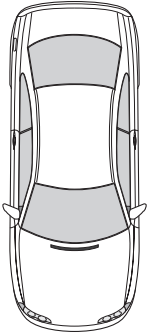
Installed by:	Illustration: 
Installed date:	
Configured frequency:	
Serial number:	
Other notes:	



Universal RDS
www.diceelectronics.com

UNI-150-PRO-033111