

MODEL 163.113 /136 /154 /157 /172 with CODE (221b) Electrically adjustable driver and passenger seat

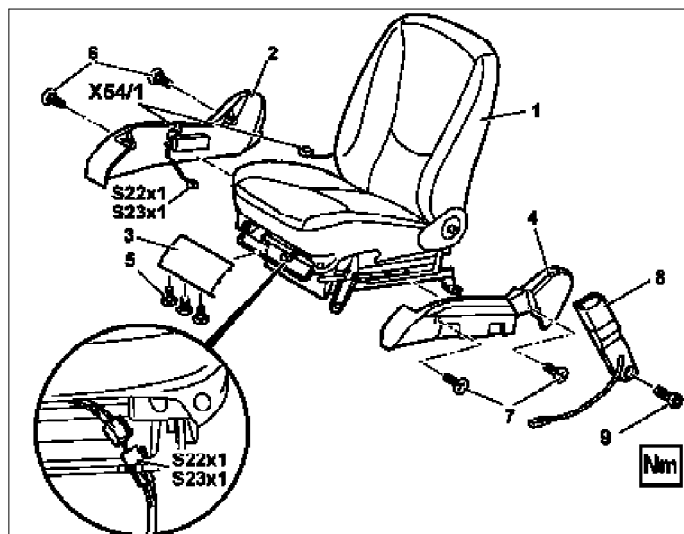





MODEL 163.128 /174 /175

Shown on right front seat

- 1 Front seat
- 2 Outer paneling
- 3 Front paneling
- 4 Inner paneling
- 5 Screws
- 6 Screws
- 7 Screws
- 8 Front seat seat belt buckle
- 9 Internal Torx drive bolt
- S22x1 Left front seat adjustment switch connector
- S23x1 Right front seat adjustment switch connector
- X54/1 Seat adjustment connector



P91.10-0548-11

 	Remove/install		
1.1	Remove front seat	 Only necessary when removing the inner paneling (4).	AR91.10-P-1000GH
2	Unscrew screws (5) from the front paneling (3)		
3	Pull down the front paneling (3) approx. 1 cm as far as the stop and remove forwards		
4	Remove electrical line from the clips on the front paneling (3)		
5.1	Disconnect left front seat adjustment switch connector (S22x1) or right front seat adjustment switch connector (S23x1) at front seat frame	 Up to 08/98.	
6	Unscrew screws (6) from outer paneling (2)		
7	Remove outer paneling (2)		
8.1	Disconnect left front seat adjustment switch connector (S22x1) or right front seat adjustment switch connector (S23x1) from seat adjustment switch unit	 As of 09/98.	
9.1	Separate seat adjustment connector (X54/1) from seat adjustment switch unit	 Not fitted with memory switch for left electrically adjustable front seat, code 241 or with memory switch for right electrically adjustable front seat, code 242a.	
10	Remove electrical line from the clips on the outer paneling (2)		
11	Unscrew screws (7) from inner paneling		
12	Remove inner paneling (4)		
13	Install in the reverse order		